

# BÜSSER HAUSBAU AG



BÜSSER HAUSBAU AG  
Erdelhölzstr. 15  
8645 Reppeswil - Jona  
Telefon 055220 66 22  
FAX 055220 66 29

Markthäuschen, 8645 Jona

## Ansichten Grundhaus

Maßstab	1 : 50	Format	A4 210x297mm	Planer	M. Kozak
---------	--------	--------	--------------	--------	----------

13-363/h05

DATUM:  
29.4.2013

REVIDIERT:  
....

S:\Aktuelle Projekte\Wick\Element\Baracke\Markhäuschen.rvt

### Frontansicht

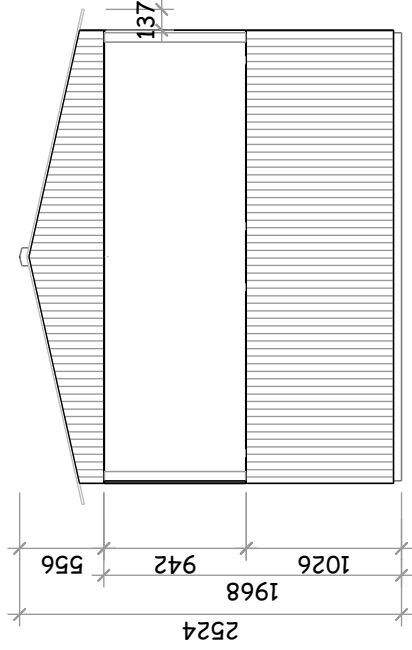

### Seitenansicht

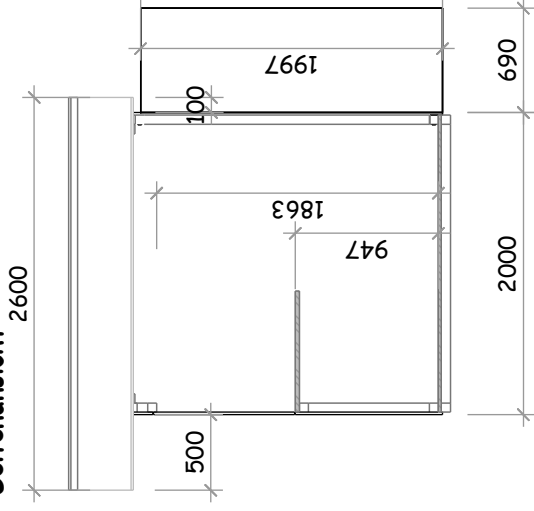

### Grundriss

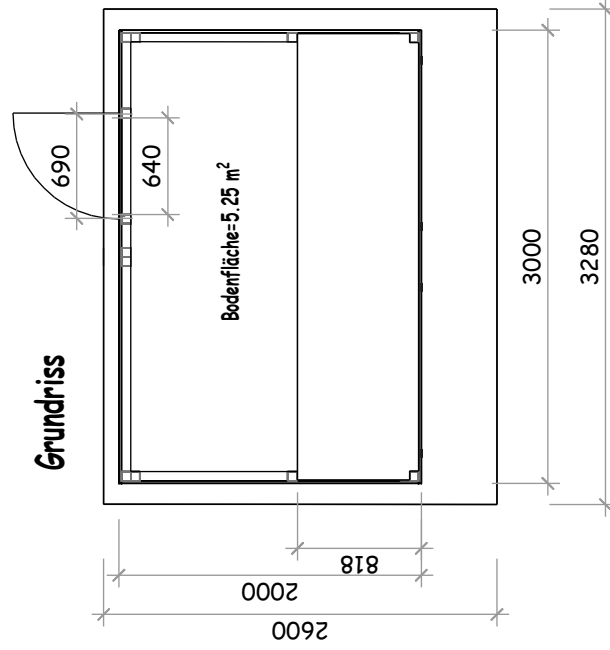



Markthäuschen, 8645 Jona

## Ansichten Türe rechts

Maßstab	1 : 50	Format	A4 210x297mm	Planer	M. Kozak
---------	--------	--------	--------------	--------	----------

13-363/h06

DATUM:  
29.4.2013

REVIDIERT:  
....

S:\Aktuelle Projekte\Wick\Elemente\Baracke\Markthäuschen.rvt

### Frontansicht

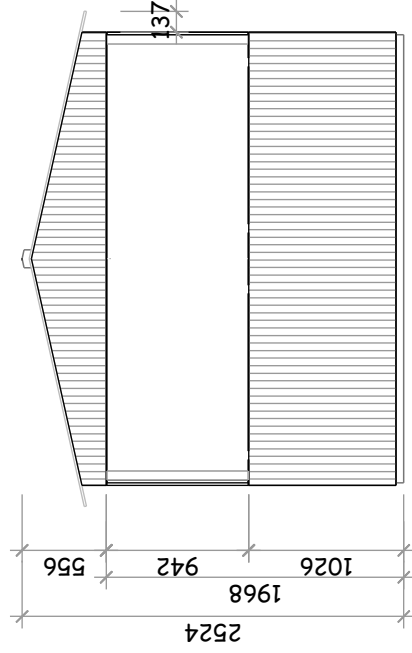

### Seitenansicht

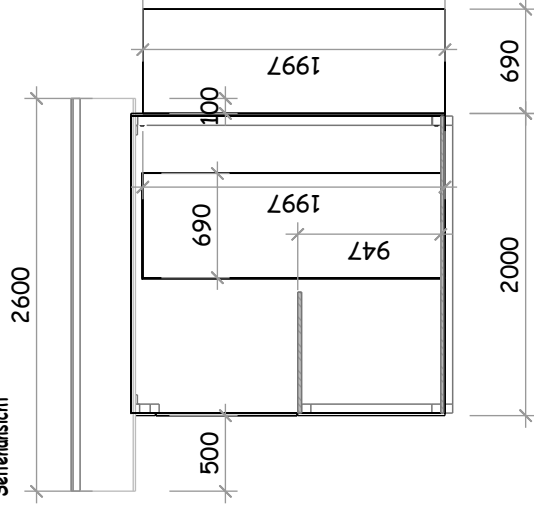

### Grundriss

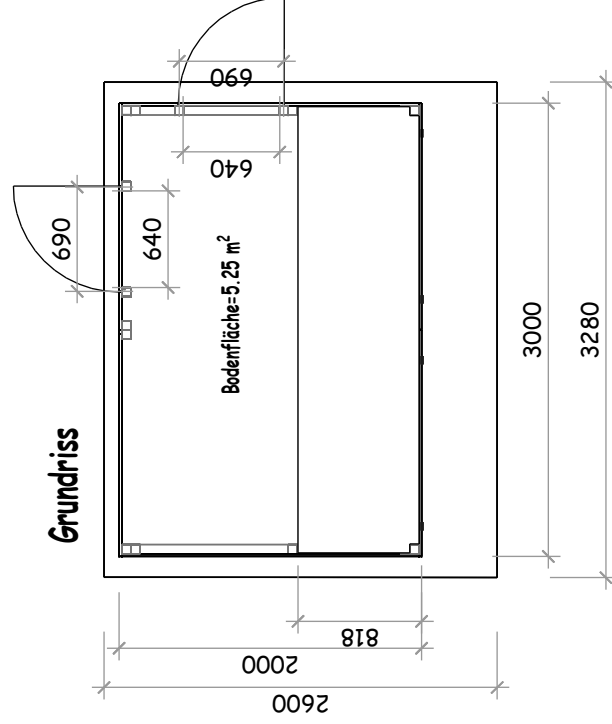



Markthäuschen, 8645 Jona

## Ansichten Türe links

Maßstab	1 : 50	Format	A4 210x297mm	Planer	M. Kozak
---------	--------	--------	--------------	--------	----------

13-363/h07

DATUM:  
29.4.2013

REVIDIERT: ....

S:\Aktuelle Projekte\Werk\Element\Baracke\Markthäuschen.rvt

### Frontansicht

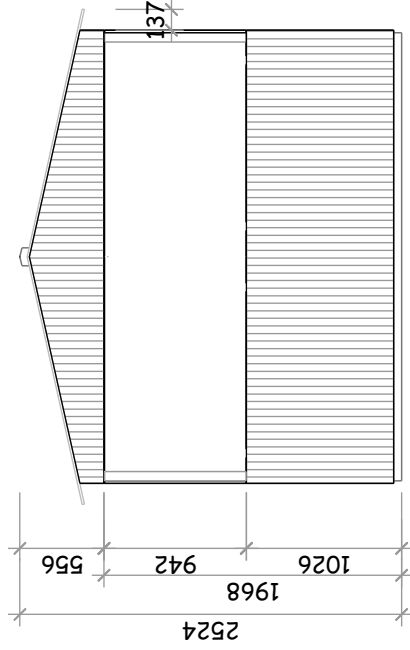

### Seitenansicht

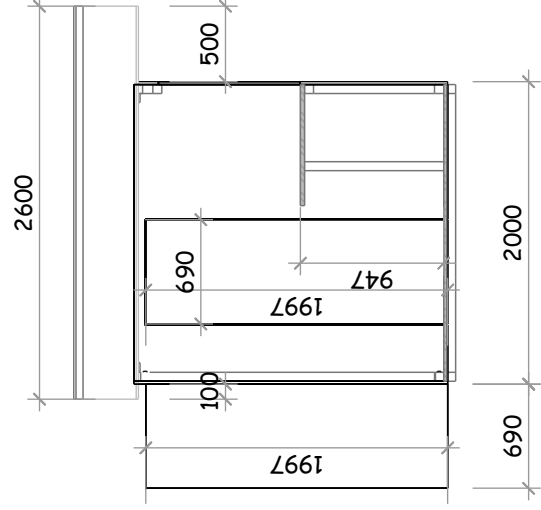

### Grundriss

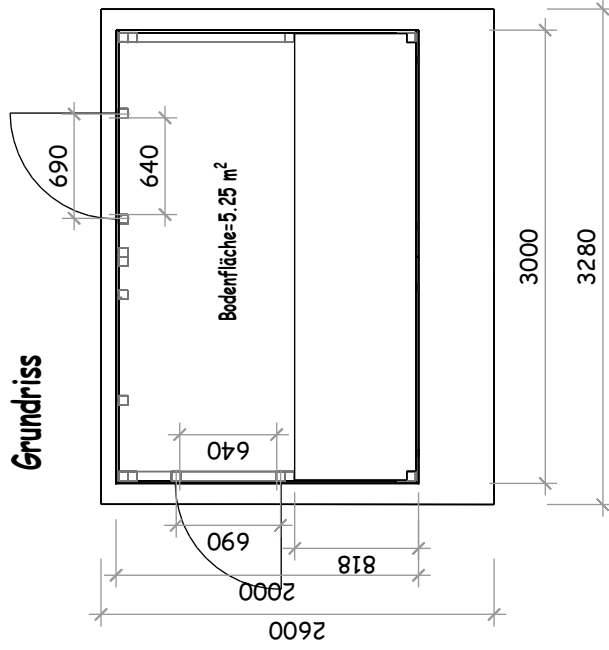

# BÜSSER HAUSBAU AG



BÜSSER HAUSBAU AG  
Engelhölzistr. 15  
8645 Rapperswil - Jona  
Telefon 055/220 66 22  
FAX 055/220 66 29

Markhäuschen, 8645 Jona

13-363/h08

DATUM:  
29.4.2013

## Ansichten Doppelhaus

REVIDIERT: ....

Massstab 1 : 50    Format A4 210x297mm    Planer M.Kozak

S:\Aktuelle Projekte\Wick\Element-Baracke\Markhäuschen.2d

### Frontansicht

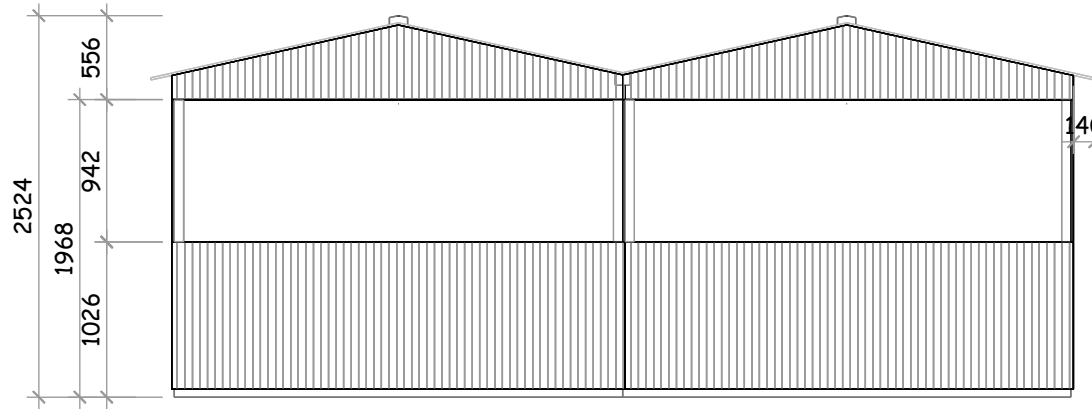

### Seitenansicht

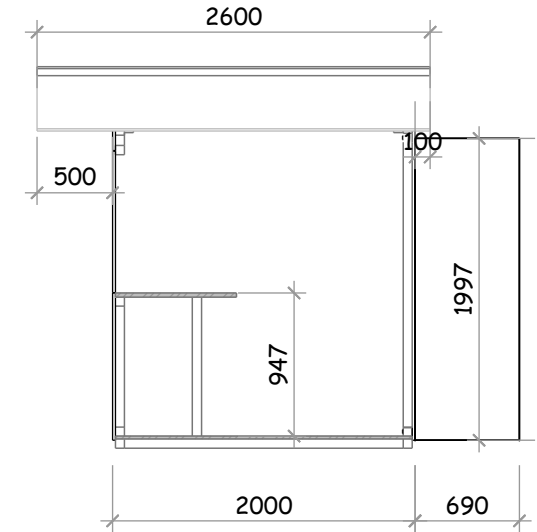

### Grundriss

